

# 1025NC Single Stage Heat Only

*Model number is located on back  
of thermostat*

- |                         |                             |
|-------------------------|-----------------------------|
| 1 Specifications        | 5 Setting User Options      |
| 2 About Your Thermostat | 6 Operating Your Thermostat |
| 3 Installation          | 7 Thermostat Maintenance    |
| 4 System Testing        |                             |



**Warning** *Turn off power to the heating equipment before installation.*



**Attention** *For installation by experienced service technicians only.*

### ***Read all instructions before proceeding.***

*This thermostat requires 24 Volt AC Power or two (2) properly installed "AA" Alkaline batteries for proper operation. When connecting 24 Volt AC Power the batteries may be installed as a backup.*

***For use only as described in this manual. Any other use will void warranty.***

## 1 Specifications

### **This thermostat is compatible with:**

- Single stage heat only systems
- 250 – 750 millivolt heat only systems
- 2 or 3 wire hydronic zone systems

### **Electrical and control specifications:**

- Electrical Rating: 24 Volt AC
- 1 amp maximum load per terminal
- AC Power: 18 – 30 Volts AC
- DC Power: 3.0 Volt DC (2 "AA" Alkaline Batteries Included)
- Control Range: 45° – 90° F (7° – 32° C)
- Temperature Accuracy: +/- 1° F (+/- .5° C)

### **Terminations**

- 1025NC – R, G, W1, V3, C

## 2 About Your Thermostat

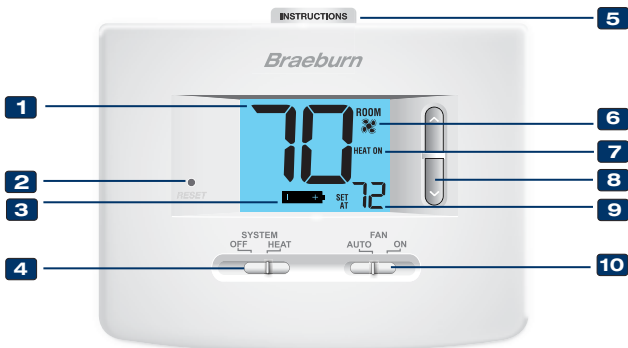

- 1 Room Temperature** .....Displays the current room temperature
- 2 Reset Button** .....Resets thermostat back to factory defaults
- 3 Low Battery Indicator** .....Indicates when the batteries need to be replaced
- 4 System Switch**.....Selects heat on or off
- 5 Quick Reference Instructions** .....Stored in slot at top of thermostat
- 6 Fan Indicator** .....Indicates when the system fan is running
- 7 System Status Indicator**...Displays information about the status of the system
- 8 Arrow Buttons** .....Used to increase or decrease settings
- 9 Set Temperature** .....Displays the current set point temperature
- 10 Fan Switch**.....Selects the system fan mode
- Battery Compartment**.....Located in the back of the thermostat

## 3 Installation

 **Warning** *Disconnect power before beginning installation.*

### Thermostat Location

Install the thermostat approximately 5 feet (1.5m) above the floor in an area that has a good amount of air circulation and maintains an average room temperature.

Avoid installation in locations where the thermostat can be affected by drafts, dead air spots, hot or cold air ducts, sunlight, appliances, concealed pipes, chimneys and outside walls.

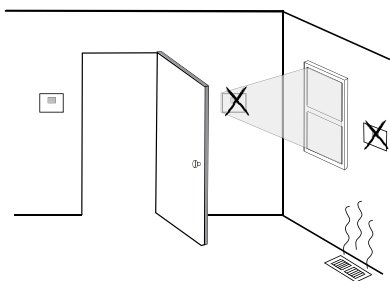

## Install your new Braeburn thermostat in 5 basic steps:

- 1 Install the Sub-Base
- 2 Provide Power
- 3 Connect Your Wires
- 4 Set Installer Switches
- 5 Attach Thermostat to Sub-Base

### 1 Install the Sub-Base:

- Remove the sub-base from the body of the thermostat.
- Mount the sub-base as shown below:

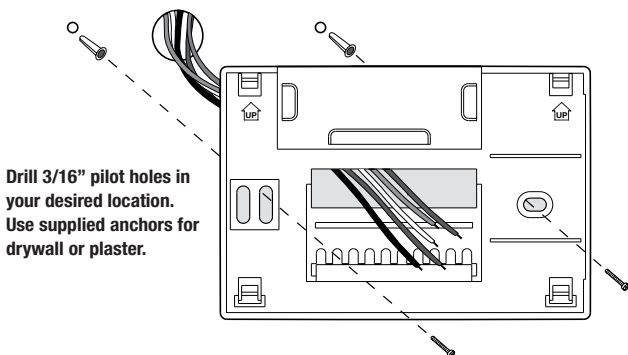

**NOTE:** After sub-base installation, you may insert the quick reference card into the slot on the top of the base.

### 2 Provide Power

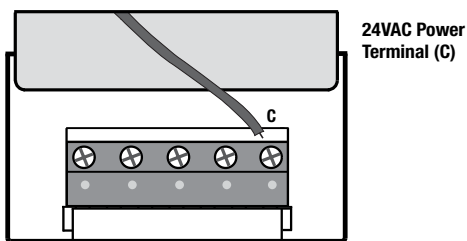

- **For 24 Volt AC power**, you must connect the common side of the transformer to the C terminal on the thermostat sub-base.
- **For primary or back-up power**, insert the 2 supplied "AA" type alkaline batteries into the battery compartment located in the rear housing of the thermostat. Make sure to position the Positive (+) and Negative (-) sides of the batteries correctly with the +/- symbols in the battery compartment.

### 3 Connect Your Wires

#### Wiring Terminations

Terminal	Function	Description
R	Input	Power Connection (24 Volt AC Heating Transformer or Millivolt Power Source)
G	Output	Fan Control
W1	Output	Conventional Heat Control
V3	Output	Zone Valve Power Close
C	Input	24 Volt AC Transformer Common

#### Conventional Systems

#### Typical Wiring Configurations

##### Heat Only or Millivolt

<b>R</b>	Power Connection
<b>W1</b>	Heat Relay
<b>G</b>	Fan Control <b>[note 3]</b>
<b>C</b>	24 Volt AC Transformer Common <b>[note 2]</b>

### 3 Wire Hydronic Zone Valve

<b>R</b>	Power Connection
<b>W1</b>	Zone Valve Power Open
<b>V3</b>	Zone Valve Power Close <b>[note 1]</b>
<b>G</b>	Fan Control <b>[note 3]</b>
<b>C</b>	24 Volt AC Transformer Common <b>[note 2]</b>

#### NOTES - Conventional Systems

**[1]** For a 2-wire zone valve you will not connect V3

**[2]** If batteries are installed, the 24 Volt AC common connection is optional

**[3]** If needed for system

*Provide disconnect and overload protection as required.*

## 4 Set Installer Switches

Switch	Factory Default	Setting Options	Comments
F / C	F	F	Select for fahrenheit temperature scale
		C	Select for celsius temperature scale
HE / HG	HG	HG	Select for gas heat or hydronic systems without fan
		HE	Select for electric heat or hydronic systems with fan

**NOTE:** The reset button should be pressed after making any changes to the installer switches.

## 5 Attach Thermostat to Sub-Base

1. Line up the thermostat body with the sub-base.
2. Carefully push the thermostat body against the sub-base until it snaps into place.
3. Insert quick reference card into slot on top of thermostat.

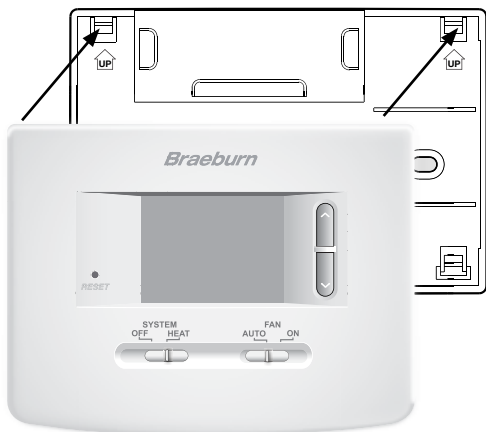

## 4 System Testing



### **Warning** *Read Before Testing*

- Do not short (or jumper) across terminals on the gas valve or at the system control board to test the thermostat installation. This could damage the thermostat and void the warranty.
- 1 Move the **SYSTEM** switch to ON mode.
  - 2 Press **▲** to raise the set temperature a minimum of 3 degrees above the current room temperature. The system should start within a few seconds. With a gas heating system, the fan may not start right away.
  - 3 Move the **SYSTEM** switch to the OFF mode. Allow the heating system to fully shut down.
  - 4 Move the **FAN** switch to the ON mode. The system fan should start (on systems where a fan is installed) within a few seconds.
  - 5 Move the **FAN** switch to the AUTO mode. Allow the system fan to turn off.

## 5 Setting User Options

### **Advanced User Options**

User options allow you to customize some of your thermostats features. The default user options are compatible with most applications, therefore it is not required that you adjust them.

**To access the User Options menu, hold down both the ▲ and ▼ buttons for approximately 3 seconds until the screen changes and displays the User Option.**

Press the **▲** or **▼** button to change the setting for the displayed User Option. After you have made your desired setting, press **▲** and **▼** together to return to the normal mode.

The thermostat will also return to normal mode after your last user option is made or after no keys have been pressed for 15 seconds.

## Table of User Options

No.	User Options	Factory Default	Setting Options	Comments
1	1st stage differential	0.5	0.5, 1.0 OR 2.0	Select a 1st stage temperature differential of .5°, 1° or 2°F (.25°, 5° or 2°C)

### ***Detailed Explanation of User Options:***

#### **Temperature Differential**

The differential setting is the temperature control range that your thermostat will provide. The smaller the setting, the tighter your range of temperature control and comfort will be.

## 6 Operating Your Thermostat

### **Setting the System Control Mode**

The System Control has two modes of operation—OFF and HEAT. The mode can be selected by moving the SYSTEM switch to the appropriate position.

**OFF** Heating system is off.

**HEAT** Your heating system will operate.

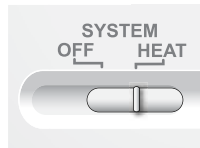

### **Setting the Fan Control Mode**

*The Fan Control has 2 modes of operation – AUTO and ON. The mode can be selected by moving the FAN switch to the appropriate position.*

**AUTO** The fan will run when required by the system.

**ON** The fan will run continually.



**NOTE:** *Some system types do not have a fan control mode.*



## Temperature Adjustment

Press the **▲** or **▼** button to adjust the current set point temperature.

## Status Indicators

Status indicators appear in the display to let you know if your system is on or off.

**HEAT ON** Indicates your heating system is running.

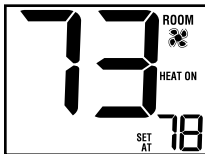

## Resetting the Thermostat

This thermostat provides you with a reset button that will erase all of your user settings.

To reset the thermostat, use a small object such as a tooth pick or paperclip and gently press the button located inside the small hole on the front of the thermostat housing labeled "reset".

## 7 Thermostat Maintenance

### Changing the Batteries

Depending on your particular installation, this thermostat may be equipped with two (2) "AA" type alkaline batteries.

**If batteries are installed and they become low, a low battery indicator will appear in the display.** You should change your batteries immediately when you see the low battery signal by following these instructions.

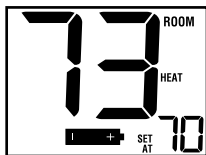

**NOTE:** We recommend replacing the thermostat batteries annually or if the thermostat will be unattended for an extended period of time.

1. Remove thermostat body by gently pulling it from base.
2. Remove old batteries and replace with new batteries.
3. Make sure to correctly position the (+) and (-) symbols.
4. Gently push thermostat body back onto base.

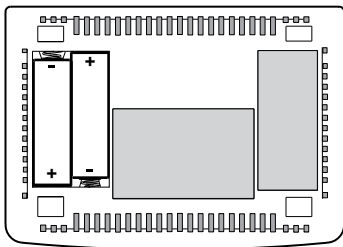

## Thermostat Cleaning

Never spray any liquid directly on the thermostat. Using a soft damp cloth wipe the outer body of the thermostat. Never use any abrasive cleansers to clean your thermostat.

**For troubleshooting tips, visit [braeburnonline.com](http://braeburnonline.com).**

***Store this manual for future reference.***

## Limited Warranty

When installed by a professional contractor, this product is backed by a 5 year limited warranty. Limitations apply. For limitations, terms and conditions, you may obtain a full copy of this warranty:

- Visit us online: [www.braeburnonline.com/warranty](http://www.braeburnonline.com/warranty)
- Phone us: 866.268.5599
- Write us: Braeburn Systems LLC  
2215 Cornell Avenue  
Montgomery, IL 60538



# ***Braeburn***<sup>®</sup>

Braeburn Systems LLC  
2215 Cornell Avenue • Montgomery, IL 60538  
Technical Assistance: [www.braeburnonline.com](http://www.braeburnonline.com)  
Call us toll-free: 866-268-5599 (U.S.)  
630-844-1968 (Outside the U.S.)